

FAQs

What is included in the TempWall system?

The system has:

- 1 x Fully assembled wall
- 2 x Foot plates
- 2 x U-style top/bottom clips
- 2 x T-style top/bottom clips
- 20 x Stainless steel screws



Foot plate

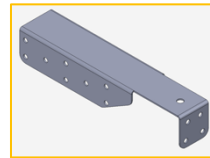

U-style clip

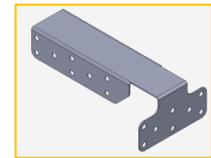

T-style clip

What are the dimensions and weight of the panels?

There are two dimensions available.

1. **TW2880MBA**: Pre-assembled wall section is 28.5" wide x 80" high x 1-3/8" deep (72.4 cm x 203.2 cm x 3.49 cm) and weighs 27 lbs (12.25 kg).
2. **TW6080MBA**: Pre-assembled wall section is 60" wide x 80" high x 1-3/8" deep (152.4 cm x 203.2 cm x 3.5 cm) and weighs 50 lbs (22.68 kg).

Do I need any additional tools for assembly?

Yes, you will need a cordless drill with a #2 Robertson or #2 Phillips bit. You may also need a rubber mallet when combining walls that are already assembled with foot plates.

How can I configure the panels?

The panels have many configuration options, and it will depend on the space they are being installed in and the use case. Some of the more common configurations include:

- Single stand-alone
- L-shape
- U-shape
- Double-U
- Multi-U
- Zigzag

Diagrams of possible combinations are below.

TW2880MBA Configurations

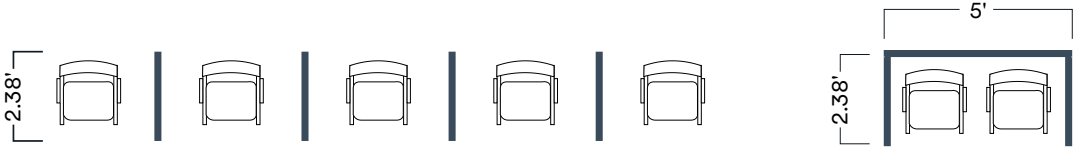

Stand-alone

U-shape

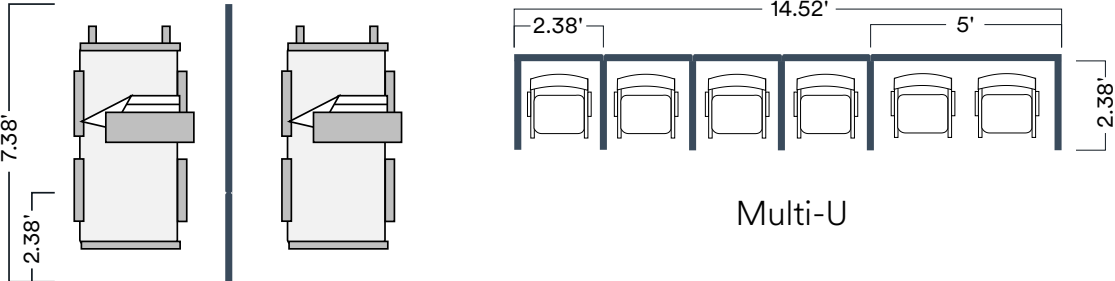

Inline

Multi-U

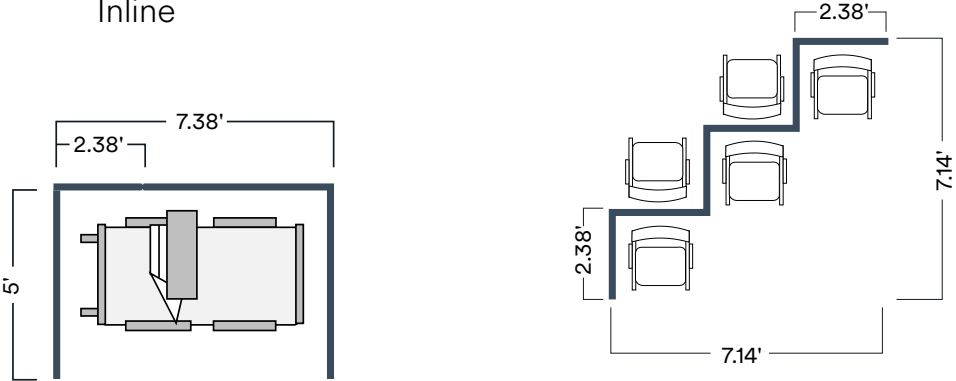

Extended U-shape

Zig-zag

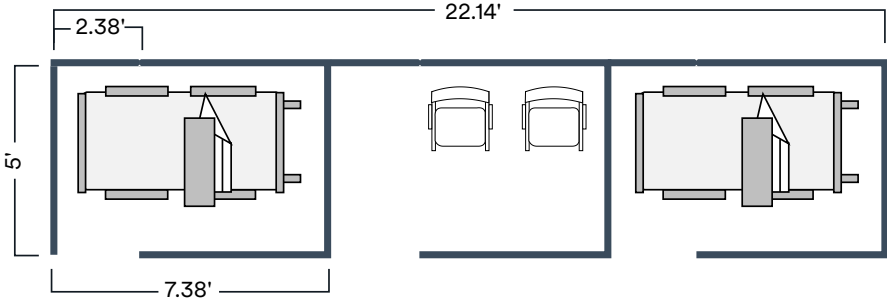

Multi-U Privacy

TW6080MBA Configurations

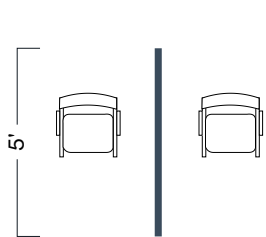

Stand-alone

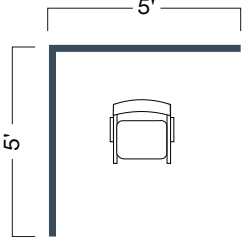

L-shape

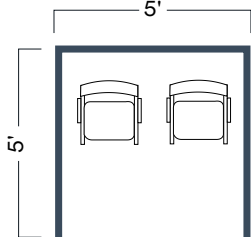

U-shape

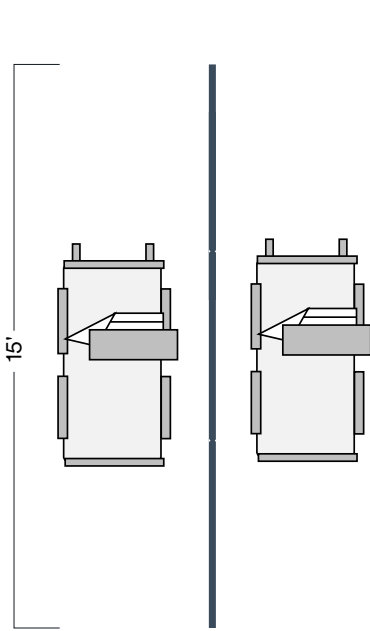

Inline

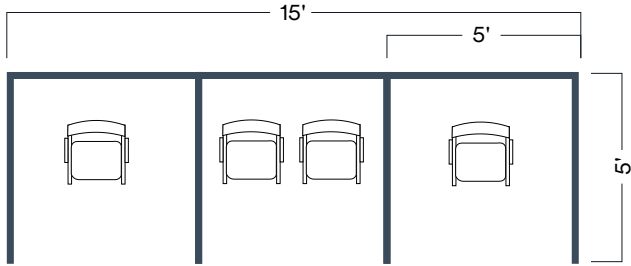

Multi-U

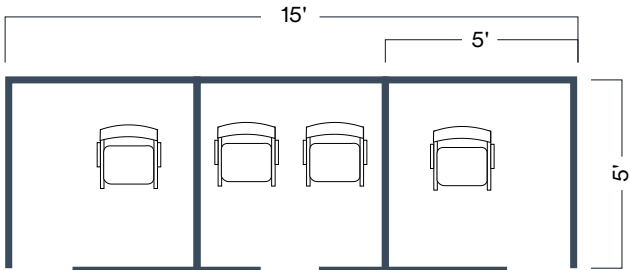

Multi-U Privacy

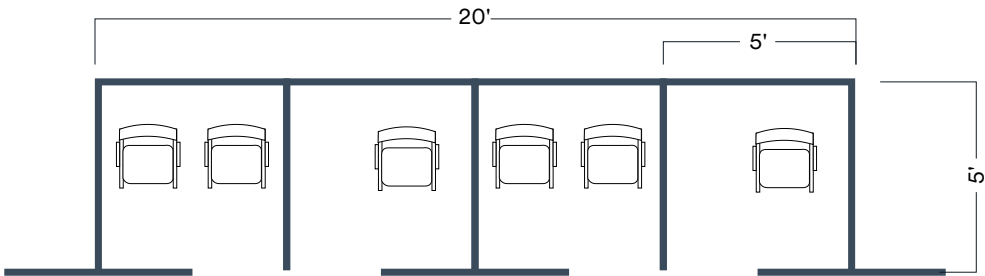

Multi-U Privacy

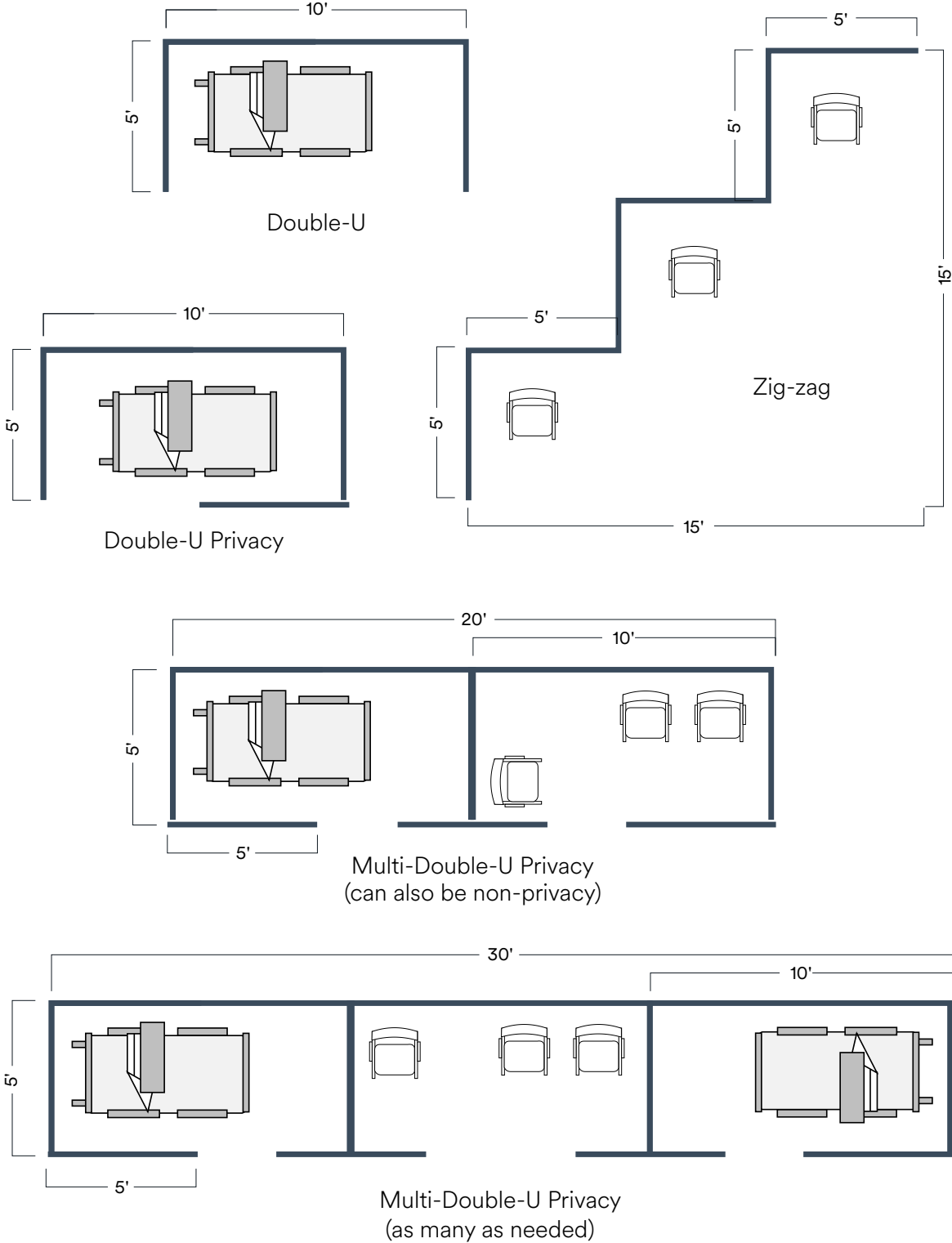

How long does it take to assemble the system?

It will take less than 1 minute to assemble a stand-alone configuration, and approximately 5-10 minutes for a U-shape configuration.

If combining the walls inline, it is recommended to slide the tongue and groove of the walls together before adding the feet. If combining the walls after the feet are installed, you may need a rubber mallet to connect the walls. See the [TempWall installation instructions](#) for more details.

Can I add casters to the foot plates?

Casters can be added to the foot plates so the walls can be easily moved around. For example, you may want a moveable wall to create privacy panels when needed. Attach the castors to the foot plates only after they have been installed on the walls. You will need to source the casters separately—3" swivel casters with 1/2-13" stem are recommended for the TempWall foot plates.

What is the lead time?

The lead time is 2-3 days to ship. Production capacity is approximately 400 TempWall systems per day.

What are the shipping options?

TW2880MBA TempWall systems can be most rapidly and optimally shipped 56 per pallet (60" x 82" x 48"). 18 pallets can be transported in a truckload for a quantity of 1008 in a 53' trailer.

TW6080MBA TempWall systems can be most rapidly and optimally shipped 28 per pallet (60" x 82" x 48"). 18 pallets can be transported in a truckload for a quantity of 504 in a 53' trailer.

The accessories (footplates, clips, and screws) will be packaged in bulk for pallet quantities, and individually if less than pallet quantity.

Is TempWall approved for use in medical facilities?

TempWall is hospital grade, and Trusscore Inc. operates under a Health Canada Class 1 Medical Device Establishment License (MDEL), #11676.

An MDEL is required for the activities of importing and selling medical devices for human use in Canada.

What is Microban Aegis Microbe Shield?

Microban AEGIS® Microbe Shield helps to protect surfaces from harmful microbes. The technology polymerizes (bonds) to surfaces resulting in a strong, durable, invisible, and effective barrier with a long history of safe use. AEGIS is proven to control and prevent the growth of an extremely wide range of microorganisms such as bacteria, algae, yeasts, mold, and mildew.

It's ideal for institutional, healthcare, public shared facilities, and outdoor environments our technologies can provide an extra level of hygiene protection with a 99.9% microbial reduction rate.

More information can be found here: <https://www.microban.com/antimicrobial-solutions/technologies/aegis-microbe-shield>

Is TempWall re-usable?

TempWall can be re-used and repurposed in many ways. Because it is modular and lightweight it can be used in varied locations for different pop-up and temporary events or crisis management situations when divided spaces are required. For example, in a pandemic response situation, TempWall assets can quickly be set up in the temporary pandemic centre/overflow location, and once they are no longer needed there, they can be moved to ER and other hospital waiting areas, elder care facilities, shelters, etc.